



Pressure Transmitter

Datasheet

SUP-P400

Supmea Pressure Transmitter Datasheet

SUP-P400 Pressure transmitter

Product description

SUP-P400 Series pressure transmitter is kind of device based on pressure layer, which inside expert integrate circuit can transform sensor milli-volt signal to standard far distance transmission current signal, and it can be directly joined with computer joint clip, control instrument ,aptitude instrument or PLC etc. conveniently. The series' product is applied extensively in the professions, such as the industry process control, petroleum, chemical engineering and metallurgy etc. Carry the distance delivers and can adopt electric current exportation method.



Product advantage

- The physical volume small, the weight is ligh;
- Work in the causticity environment;
- That product installs the convenience simple and direct;
- The whole stainless steel seals completely the structure,have the very high anti- to flap to pound at the function with anti.

SUP-P400 pressure transmitter for general industrial applications is not only notable for its compact design, but it also offers excellent at an extremely competitive price. The modular design of the device allows combining a variety of process connections, pressure ranges and electrical connection variants, covering virtually all industrial application requirements.

Highlights

- (1) With display type
- (2) No display type

Fully welded pressure measuring cell with
AISI 316L stainless steel diaphragm
Accuracy, terminal based: 0.5%
temperature at zero point: $\pm 0.03\%FS/^{\circ}C$
Measuring range: -1...0-2...1000bar
Ingress protection up to IP65



Applications

Oil industry paper industry chemical industry and so on.

Options and variants



P300G: Pressure transmitter
Fins with cooling



PX300: Pressure transmitter
with digital display



P350: Hygienic Pressure
transmitter with flat film



P400: Pressure transmitter
with Shell protection

TECHNICAL DATA

The following data is provided for general applications. If you require data that is more relevant to your specific application, please contact us.

MEASURE SYSTEM:	
Application Range	Measurement of gauge and absolute pressure in gases and liquids
Measuring Range	-1...0-2...1000bar

TECHNICAL PERFORMANCE	
Pressure Type	Gauge pressure absolute pressure sealing pressure
Power Supply	12VDC 24VDC 12-36VDC
Signal Output	4-20mA 0-20mA 0-5V 1-5V 0-10V RS485
Zero Drift	$\pm 0.03\%FS^{\circ}C$
Accuracy	$\pm 0.5\%FS^{\circ}C, 0.3\%FS$ optional
Thermal Sensitivity Drift	$\pm 0.03\%FS^{\circ}C$
Long Term Stability	$\leq 0.2\%FS^{\circ}C$ one year
Frequency Response(-3dB)	5kHz~650kHz
Ingress Protection	IP65
Pressure Connection	G1/4, G1/2, 1/2NPT, 1/4NPT, M20*1.5etc.(optional)
Measure Medium	Gas, water, oil etc. (non-explosion-proof area)
Electrical Connections	DIN connector type, M12 connector, cable connector type
Time Response	< 10ms
Weight	Min, 400g (depending on model)

MATERIALS:

Housing	304/316L stainless steel
Fill Fluid	Silicon oil

WETTED PARTS:

Pressure Port	Stainless steel 304 / AISI 316L
Separating Diaphragm	Stainless steel 304/ AISI 316L
Sealing	FKM(medium temperature \leq +200°C/392°C);EPDM; NBR

VOLTAGE SUPPLY:

Output Signal	Power Supply Standard	Option
4-20 mA	12VDC	12-36VDC
0-20 mA	24VDC	12-36VDC
DC 0-5V	24VDC	12-36VDC
DC 1-5V	24VDC	12-36VDC
DC 0-10V	24VDC	12-36VDC

OUTPUT SIGNAL:

Signal Type	Signal
Current(2-wire)	4-20mA
Voltage(3-wire)	0-5V 1-5V 0-10V

OPERATING CONDITIONS:	
Temperature	-20...+80°C/-4...+176°F
Nominal Temperature	-40...+85°C/-40...+185°F
Ambient Temperature	-40...+100°C/-40...+212°F
Storage Temperature	PN≤40 bar /580 psi: -40...+125°C/-40...+257°F
Medium Temperature	PN≥60 bar /870 psi: -25...+125°C/-13...+257°F
	With cooling fins (optional) :
	PN≤40 bar /580 psi: -40...+125°C/-40...+257°F
	PN≤40 bar /580 psi: -40...+125°C/-40...+257°F

SIZE CHART:

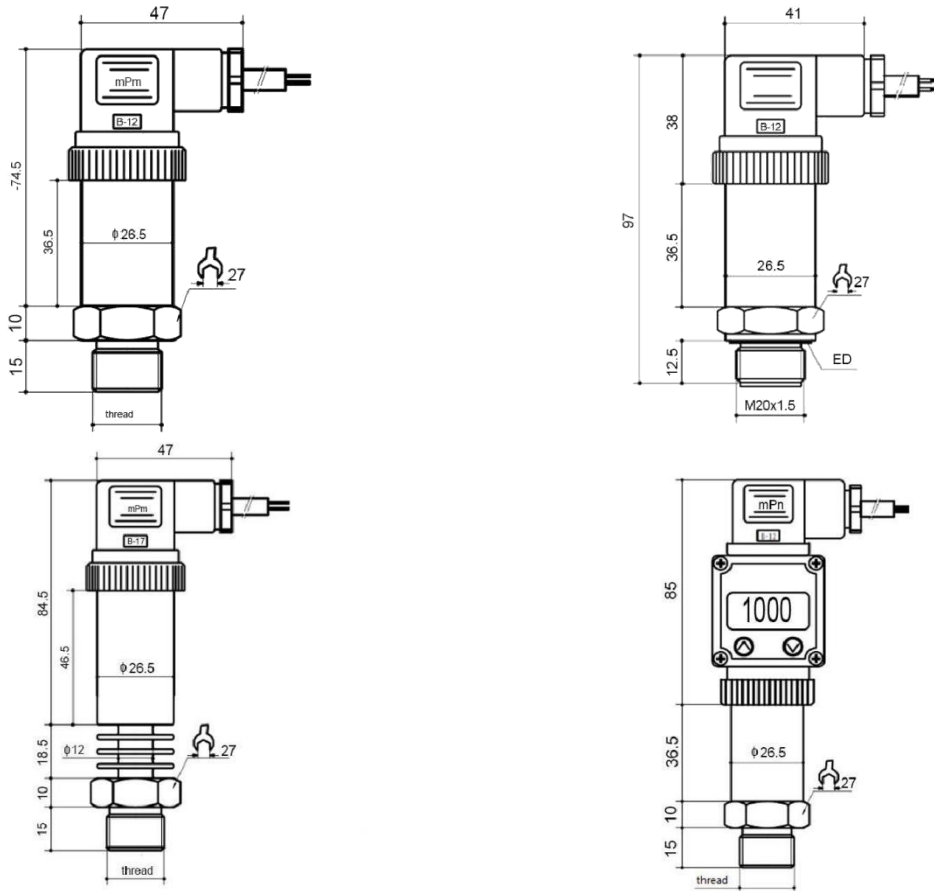

CONNECTOR TYPE:

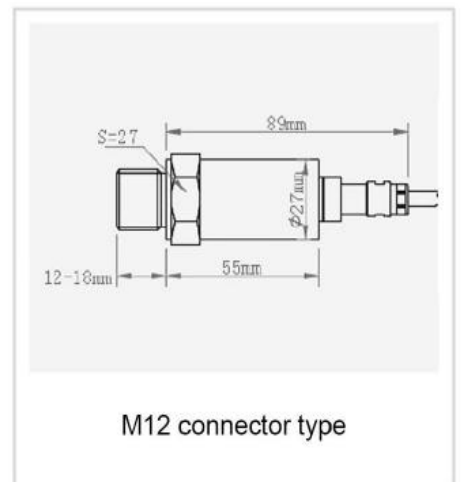
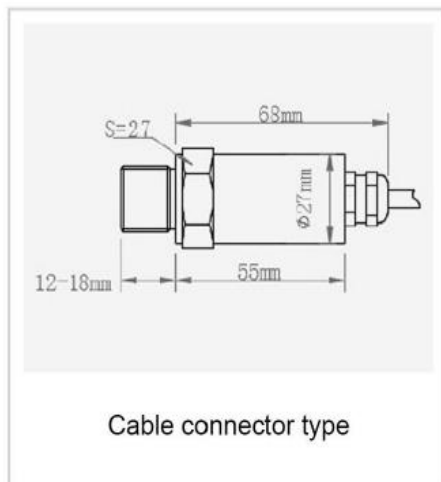
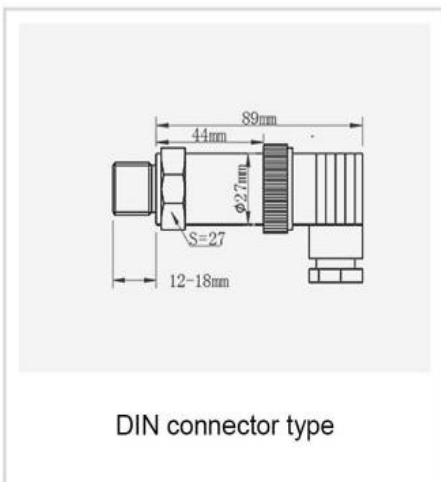

PROCESS CONNECTION:

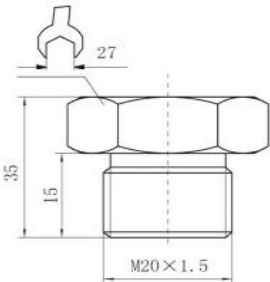
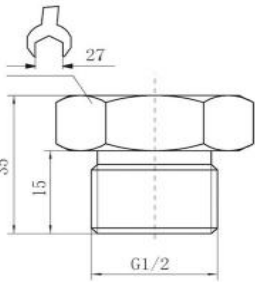
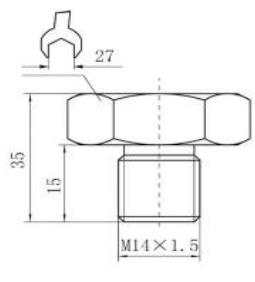
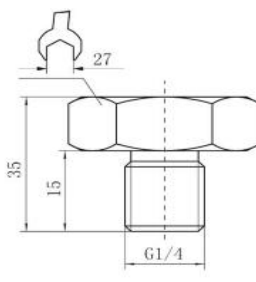
Thread	M20×1.5	G1/2	M14×1.5	G1/4
Size chart unit: mm				
No.	C1	C2	C3	C4

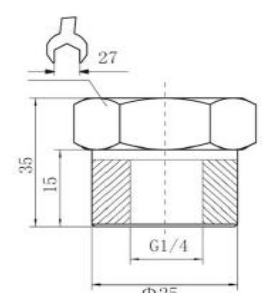
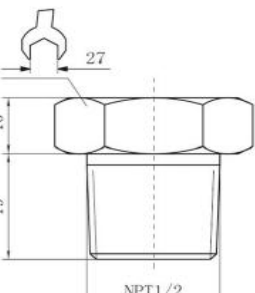
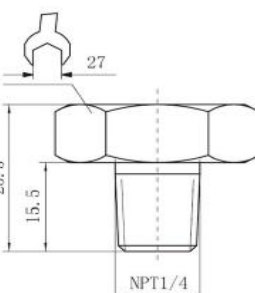
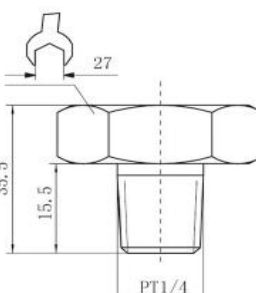
Thread	G1/4内	NPT1/2	NPT1/4	PT1/4
Size chart unit: mm				
No.	C5	C6	C7	C8

TERMINAL ASSIGNMENT:

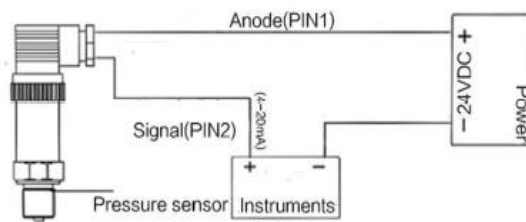

Two-wire wiring diagram

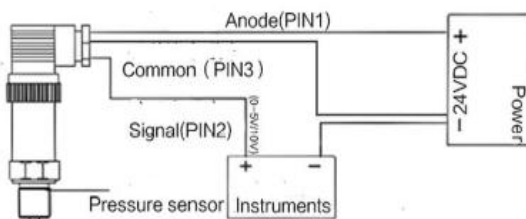

Three-wire wiring diagram

Series	
A:SUP-P300, B:SUP-P300G, C:SUP-PX300, D:SUP-P350, E:SUP-P400	
Measure Range	
1	-100 kpa/0/-1bar/0/-14psi-0
2	0-10kpa /0-0.10bar/0/-1psi
3	0-50kpa/0-0.5bar/0-7psi
4	0-200kpa/0-2bar/0-29psi
5	0-1000kpa/0-10bar/0-145psi
6	-0.1-0.1Mpa/-1-1bar/-14-14psi
7	0-0.6Mpa/0-6bar/0-87psi
8	0-1Mpa/0-10bar/0-145psi
9	0-1.6Mpa/0-16bar/0-232psi
A	0-2.5Mpa/0-25bar/0-362psi
B	0-6Mpa/0-60bar/0-870psi
C	0-10Mpa/0-100bar/0-1450psi
D	0-20Mpa/0-200bar/0-2900psi
E	0-30Mpa/0-300bar/0-4351psi
F	0-40Mpa/0-400bar/0-5801psi
G	0-60Mpa/0-600bar/0-8702psi
Power Supply	
A1	12-36VDC
A2	12VDC
A3	24VDC
Signal Output	
B1	4~20MA
B2	0~10V
B3	1~5V
Process Connections	
C1	20×1.5
C2	G1/2
C3	M14×1.5
C4	NPT1/4, etc., as required
Electrical Connectors	
D1	DIN connector type
D2	Cable connector type
D3	M12 connector type
Optional Functions	
E	Tantalum diaphragm
F	Seismic requirements
G	Compressive requirements

